

USER MANUAL



**DUST COLLECTOR ADAMIK
FT 416, FT 420, FT 440 series**

CONTENT

1. IDENTIFICATION DETAILS	4
2. BASIC INFORMATIONS	4
2.1 PURPOSE OF THE MANUAL	4
2.2 USED SYMBOLS	5
2.3 DEFINITION OF OPERATOR QUALIFICATIONS.....	6
3. SAFETY INFORMATIONS.....	6
3.1 RESIDUAL RISKS.....	7
3.2 GENERAL SAFETY WARNINGS.....	7
3.3 SAFETY PRECAUTIONS FOR HANDLING, ASSEMBLY AND INSTALLATION.....	8
3.4 SAFETY WARNINGS FOR INTENDED USE.....	8
3.5 SAFETY WARNINGS FOR ADJUSTMENT/MAINTENANCE.....	8
3.6 SAFETY WARNING FOR ENVIRONMENTAL IMPACT.....	9
3.7 SAFETY SIGNS LOCATED ON THE MACHINE.....	9
3.8 RISK OF EXTRAORDINARY FORESEEABLE SITUATION	10
4. HANDLING, ASSEMBLY AND INSTALLATION INFORMATIONS	11
4.1 HANDLING, STORAGE AND PACKAGING.....	11
4.2 INSTRUCTIONS FOR MACHINE ASSEMBLY.....	11
4.3 MACHINE ASSEMBLY.....	13
4.3.1 Filter assembly	13
4.3.2 Waste bag assembly.....	14
4.4 INSTALLATION OF THE MACHINE.....	14
4.5 ELECTRICAL CONNECTION.....	15
4.5.1 Connection to the power supply network	16
4.5.2 Wiring diagram.....	17
4.6 INSTALLATION OF OPTIONAL ACCESSORIES	17
4.7 TEST OPERATION	18
4.7.1 Starting the machine	18
5. TECHNICAL INFORMATIONS	19
5.1 MANUFACTURER AND MACHINE IDENTIFICATION	19
5.2 DESCRIPTION OF THE MACHINE AND OPERATION CYCLE	19
5.3 TECHNICAL PARAMETERS.....	20
5.3.1 Dimensions and weight of the unit – FT 416 series.....	20
5.3.2 Dimensions and weight of the unit – FT 420 series.....	21
5.3.3 Dimensions and weight of the unit – FT 440 series.....	22
5.3.4 Noise.....	22
5.3.5 Delivery contents – FT 416 series.....	23

5.3.6 Delivery contents – FT 420 series.....	24
5.3.7 Delivery contents – FT 440 series.....	25
5.4 DESCRIPTION OF SAFETY DEVICE.....	26
5.5 PERIMETER AREAS	26
6. INFORMATIONS FOR USE.....	26
6.1 RECOMMENDATIONS FOR USE	26
6.2 CORRECT USE / IMPROPER USE	27
6.2.1 Type of extracted material	27
6.3 IN THE CASE OF FIRE	27
7. MAINTENANCE.....	28
7.1 MAINTENANCE RECOMMENDATIONS	28
7.2 EMPTYING THE WASTE BAGS	29
7.3 CLEANING THE FILTERS	29
7.4 TABLE OF SCHEDULED MAINTENANCE INTERVALS	30
7.5 CLEANING AND DISPOSAL.....	30
8. TROUBLESHOOTING.....	31
9. PARTS REPLACEMENT INFORMATIONS.....	31
9.1 ORDERING SPARE PARTS AND ACCESSORIES.....	31
9.2 RECOMMENDATIONS FOR REPLACEMENT OF SPARE PARTS.....	32
9.3 LIST OF REPLACEABLE PARTS	33
9.3.1 FT 416 series	33
9.3.2 FT 420 series	36
9.3.3 FT 440 series	39
9.4 OPTIONAL EQUIPMENT	41
9.5 DECOMMISSIONING.....	42
10. AUTOMATIC START WITH MACHINE (if equipped).....	44
11. ATTACHMENT OF POLYESTER FILTERS FPEA/ FPEAC/FPEAM (if equipped)	46
12. MOTORIZED FILTER CLEANING CONTROL (if equipped).....	47
13. WARRANTY	48
13.1 LIABILITY FOR DEFECTS.....	48
13.2 VOLUNTARY ADDITIONAL WARRANTY.....	48
13.3 EXCLUSIONS FROM LIABILITY FOR DEFECTS AND FROM WARRANTY.....	48
14. TERMS OF SERVICE.....	49

1. IDENTIFICATION DETAILS

Identification details:



ADAMIK Company, s.r.o.
Mitrovická 804
739 21 Paskov, Czech Republic
VAT nr.: CZ26845318

2. BASIC INFORMATIONS

2.1 PURPOSE OF THE MANUAL

The purpose of this manual is to provide, in part, the machine operator, operator and maintenance technician with guidance on the use, prevention and reduction of human-machine interaction risks.

Person	Chapters in the manual they must familiarize themselves with
The person installing the unit	<ul style="list-style-type: none">- Basic informations- Safety informations- Handling, assembly and installation informations- Technical informations- Parts replacement informations
Operator	<ul style="list-style-type: none">- Basic informations- Safety informations- Information for use
Maintenance technician	<ul style="list-style-type: none">- Basic informations- Safety informations- Handling, assembly and installation informations- Information for use- Maintenance- Troubleshooting- Parts replacement informations

The responsible person must keep the documentation in a suitable place so that it is always available for consultation in a legible and clear state. In case of loss or wear, request replacement documentation directly from ADAMIK Company.

Specific topics of interest are easy to find in the table of contents.

Some information may not fully correspond to the actual configuration of the delivered machine.









Any additional information that may be inserted will not affect readability or compromise the level of security.





The manufacturer reserves the right to change the data without being obliged to notify in advance, as long as these changes do not change the level of safety.

Any feedback from operators can be an important contribution to improving the after-sales services that the manufacturer offers to its customers.

Some symbols, the meaning of which is described below, are used to highlight some text or to indicate significantly important specifications.

2.2 USED SYMBOLS

Symbol	Description
	Danger – Warning The symbol indicates situations of serious danger which, if neglected, may seriously endanger the health and safety of persons.
	Danger – Warning The symbol indicates situations of serious danger which, if neglected, may seriously endanger the health and safety of persons.
	Danger of explosion This symbol indicates situations of serious danger which, if neglected, can cause an explosion and seriously endanger the health and safety of people.
	Caution – Warning The symbol indicates the need to adopt reasonable behavior in order not to endanger the health and safety of people and avoid economic damage.
	Important The symbol indicates very important technical and operational information that must not be neglected.
	Use protective gloves.
	Wear safety shoes.
	Use a protective face mask.

Symbol	Description
	Use hearing protection.
	Use safety glasses.
	Use a safety helmet.
	For operations at a certain height, use a work-at-height harness.

2.3 DEFINITION OF OPERATOR QUALIFICATIONS

Some terms that are frequently used in the manual are described in order to clearly define their meaning.

Operator qualification	Description
Qualified personnel	Employees who have completed specialization, education and training courses and have experience in installation, commissioning and maintenance of equipment
Experienced maintenance technician	A technician selected and authorized from among those who have the qualifications, skills and information to perform routine and emergency maintenance interventions.

3. SAFETY INFORMATIONS



The extraction device is intended for extracting chips and sawdust from woodworking machines. It must not be used for easily flammable and explosive materials. It is not recommended for extracting abrasive materials (e.g. metals). Pieces of wood (knots, etc.) must not be extracted, which may cause breakage or deformation of the impeller. The extraction device is suitable for environments without the risk of fire.



Carefully read the instructions in this manual and the instructions specific to the machine and on the machine.

3.1 RESIDUAL RISKS

Residual risk	Description
Voltage hazard	Maintenance work carried out on the electrical parts of the machine carries with it the risk of electric shock.
Dust inhalation hazard	Maintenance activities carried out inside the machine involve the risk of inhaling potentially carcinogenic dust.
Fire hazard	Routine operations performed in spite of the prohibition described in the "Correct use/ Improper use" chapter. Maintenance operations performed despite the prohibition described in section "7.1 Maintenance recommendations".
Explosion hazard	Maintenance operations carried out despite the prohibition expressed in section "6.2 Correct use / Improper use". Maintenance operations carried out despite the prohibition expressed in section "7.1 Maintenance recommendations".
Cutting hazard	Maintenance operations carried out without the use of protective gloves for the removal of moving sheet metal parts carry the risk of cutting fingers.

3.2 GENERAL SAFETY WARNINGS

Personnel carrying out any type of intervention throughout the life of the machine must have precise technical skills, special abilities resulting from acquired and recognized experience in the sector, must be trained in the use of the necessary work tools and appropriate personal protective equipment with reference to the laws in force and in force at the location machine use.

Failure to comply with these requirements may cause harm to people's health and safety.

Use the personal protective equipment specified in the instructions.



The machine contains potentially explosive dust deposits and/or gases, therefore it is forbidden to approach or introduce any possible source of ignition into the machine:

- ***Open flame***
- ***Hot surfaces***
- ***Sparks***
- ***Gas***
- ***Electrical parts under voltage***
- ***Electrostatic charge***

3.3 SAFETY PRECAUTIONS FOR HANDLING, ASSEMBLY AND INSTALLATION

Use suitable lifting equipment for handling and take all safety precautions for the activities carried out in the workplace.

Before moving the machine, disconnect it from the electrical supply and the piping system.



Electrostatic charge built up in flexible pipes could ignite a fire. Therefore, they must have electrical conductivity and be grounded.



The machine must be installed in an area where there is no explosion hazard.

3.4 SAFETY WARNINGS FOR INTENDED USE

The machine was designed to work within the limits prescribed and indicated in the manual.

The machine is designed for operation in an environment protected from atmospheric weather.

Using the machine to achieve production levels other than those described in this manual will be considered "IMPROPER USE".

Carefully read the instructions in the section "6. Information for use".

To be prepared for emergency situations, carefully read the instructions in section "6.3 In case of fire".

3.5 SAFETY WARNINGS FOR ADJUSTMENT/MAINTENANCE

Perform routine maintenance as described in this manual.

Before any maintenance, disconnect the machine from all power sources.



Potentially explosive atmospheres may occur during adjustment and maintenance, therefore it is prohibited to approach or introduce any possible source of ignition into the machine:

- ***Open flame***
- ***Hot surfaces***
- ***Sparks***
- ***Gas***
- ***Electrical parts under voltage***
- ***Electrostatic charge***

3.6 SAFETY WARNING FOR ENVIRONMENTAL IMPACT

Before using the machine, the operator must be provided with information, instructions and training on the substances for which the machine is to be used, including how to safely remove and dispose of accumulated pollutants.







Do not disperse polluting material into the environment. Dispose in accordance with applicable laws.



 ***Improper cleaning or insufficient replacement of filters can cause the dispersion of pollutants in the external environment.***

3.7 SAFETY SIGNS LOCATED ON THE MACHINE

The following warning labels must be placed on the machine. see the summary diagram included in this section.

Some tags may not be present if they refer to optional components that are not installed.

Symbol	Description
	Grounding
	Danger of drawing limbs, hair and loose parts of clothing into the device's entrance openings.
	Keep limbs, hair, and loose clothing away from the inlet openings. They can be pulled into the inlet openings of the device, which could cause injury.
	Warning.
	Direction of rotation of the rotor.
	DANGER! Risk of serious cuts. Before removing dust caps and hoses, unplug the extractor from the power source and wait 5 minutes for the internal rotating parts to stop.

Symbol	Description
	<p>CAUTION! To reduce the risk of injury from moving parts, keep hands and fingers away from inlet openings. Operate the unit only with inlet openings covered with covers or connected to a flexible hose. The impeller continues to rotate for 5 minutes after the dust collector is turned off. Before servicing or cleaning dusty materials, make sure the dust collector is turned off, disconnected from the power source, and that the impeller has stopped rotating.</p>
	<p>WARNING! This appliance contains dust hazardous to health. Waste bag and filter emptying and maintenance operations, including the removal of dust collection components, must only be carried out by authorised personnel wearing appropriate personal protection. Do not operate the dust collector without the filter system fully installed.</p>

3.8 RISK OF EXTRAORDINARY FORESEEABLE SITUATION

If an object gets caught in the impeller (long wet chips, rags, paper) it will cause sudden vibrations. The extraction device must be switched off, wait until the impeller stops, and unplug the power cord from the electrical outlet. Then the pipes (hoses, pipe elements) must be dismantled, the impeller cleaned and reassembled.

Qualified personnel must carry out a technical inspection at least once a year, which consists of, for example, checking the filter for damage, checking the air tightness of the machine and the pipe system and the correct functioning of the control and regulation mechanism.

4. HANDLING, ASSEMBLY AND INSTALLATION INFORMATIONS

4.1 HANDLING, STORAGE AND PACKAGING



The standard packaging of the machine does not guarantee protection against rain. The machine must be stored in a closed environment with a relative humidity lower than 70%.



The machine must be stored at temperatures between -10 °C and +40 °C inclusive.



Use appropriate lifting equipment when handling materials and observe all safety precautions required for workplace activities. Dispose of the packaging material in accordance with applicable legislation.



The machine is delivered in a disassembled state.

Provide a defined and adequate area with a level floor or surface for unloading and storing packages.

It is always advisable to keep the packaging in a horizontal position during handling to prevent loss of stability and/or tipping over.

4.2 INSTRUCTIONS FOR MACHINE ASSEMBLY



The machine needs to be assembled.



The machine must be installed in a fixed position. The machinery must be mounted in the location specified by the operator's project.



The simultaneous presence of two qualified persons is necessary to assemble the machine. They must complete specialization and training courses and must have experience installing, activating and performing system maintenance.



The machine must not be assembled by persons under the influence of alcohol, drugs or any other intoxicating substances. Otherwise, there is a risk of injury or death.



Before starting the assembly, it is necessary to familiarize yourself with the instructions for assembly and use of the dust collector unit. The individual assembly steps must be carried out exactly in the order given in this manual.



Before assembly, visually inspect the material to ensure that it has not been damaged in transit. If it shows signs of damage, please notify the seller within 2 days of delivery.



Before proceeding with the assembly, read the paragraph "4.5 Installing the machine".



During assembly, use the personal protective equipment specified in the manual.



For transport reasons and/or on the basis of special agreements between the customer and the supplier, the parts required to assemble the machine may differ from the parts described in the assembly description.



Before opening the package, tilt the box just enough to prevent the material from tipping over. Do not exceed the maximum angle shown in the figure below.

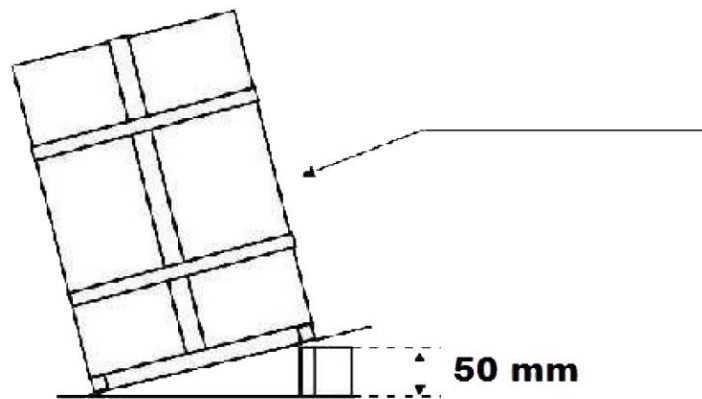

Before assembly, it is necessary to know the weight of the components.



Use suitable lifting equipment for handling. Take all the safety precautions prescribed for the activities carried out in the workplace.



Electrostatic charge accumulated in flexible pipes could cause a fire. Therefore, they must be electrically conductive and grounded.



The machine must be installed in a non-explosive environment.



The dust collector unit is designed for operation in an environment protected from atmospheric weather.



For information on the correct installation of the machine and the correct dimensioning of the suction pipe, please contact the technical department of ADAMIK Company in advance.

4.3 MACHINE ASSEMBLY



Use personal protective equipment during assembly.

Equalization of potentials

The conductive parts of the extraction device must be connected to each other and to the protective conductor of the power supply. Care must be taken to ensure that additional conductors provided by the manufacturer are not removed or damaged.

It is recommended to install the extraction device unit near utility networks and connect it to the extracted machine using pipes or hoses.

The extraction device is supplied disassembled. Qualified personnel must carry out the assembly themselves.

- The body of the extraction device with the motor and the connecting cord is attached to the metal stand with nuts.
- The filters are attached to the upper part of the circular segment using a clamp (see „4.3.1 Filter assembly“).
- The waste bags are attached to the lower part of the circular segment using a clamp (see „4.3.2 Waste bag assembly“).
- After assembly, the extraction device is placed in the designated location. The extraction device is connected to the machine tool using pipe elements or a flexible hose.
-



To dissipate electrostatic charge, the extraction device must be grounded (either by connecting to a protective connection or to the ground itself) by a person with appropriate electrical qualifications.



The room in which the extraction device with is located must be sufficiently ventilated. The ventilation must comply with the relevant national standards.

- The extraction device is connected to the electrical outlet with a plug.
- The extraction device is put into operation by turning on the switch.
- The extraction device is put out of operation by turning off the switch.

4.3.1 Filter assembly



Use personal protective equipment during assembly.

1) Unfold the filter along its entire length and thread the clamp supplied with the machine through the hem of the open edge of the filter.

2) Place the open edge of the filter onto the upper circular segment at the top of the unit body.

3) Hang the top loop of the filter into the hook of the filter holder or insert the rod of the filter holder into the filter pocket on the side of the filter holder (depending on the type of filter).

Install the other filters in the same way.



The filter must be installed correctly. Incorrect installation of the filter can lead to leaks. A filter that shows signs of leakage even when installed correctly must be replaced.

4.3.2 Waste bag assembly



Use personal protective equipment during assembly.

1) Unfold the filter along its entire length.

- For PVC waste bags place the open edge on the lower circular segment at the bottom of the unit body. Fix the bag using the clamp supplied with the machine.

- For reinforced PE waste bags and textile waste bags, thread the strap supplied with the machine through the hem of the open edge of the waste bag. Fix the bag using the clamp supplied with the machine.

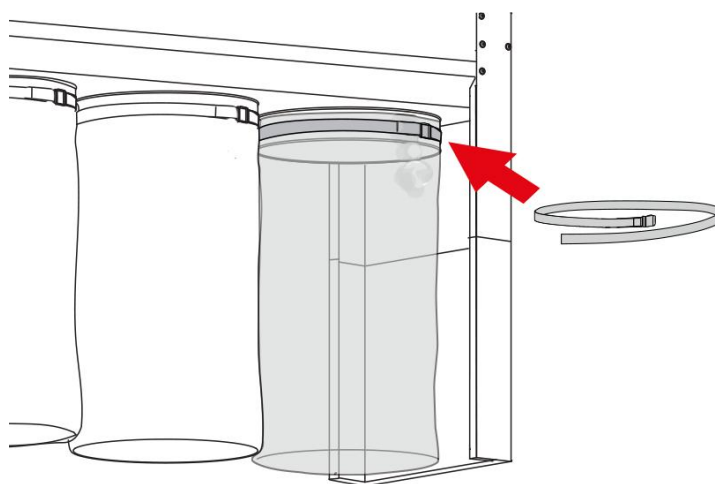

Install the other waste bags in the same way.



The waste bag must be installed correctly. Incorrect installation of the waste bag can lead to leaks. A waste bag that shows signs of leakage even when installed correctly must be replaced. If a single-use polyethylene bag is used, a simple bag change is required.

4.4 INSTALLATION OF THE MACHINE



Use personal protective equipment during assembly.



Use personal protective equipment as specified in the instructions.



The machine is designed for operation in an environment protected from atmospheric weather.



For information on the correct installation of the machine and the correct dimensioning of the suction pipe, please contact the technical department of ADAMIK Company in advance.



Before handling the machine, check that the overall dimensions and weights are necessary to carry out work and maintenance without any restrictions on handling and positioning the machine.



The machine must be installed on a flat surface.



Before starting installation, make sure that the distance between the extraction device and the work surfaces is sufficient to minimize the risk of inhaling dust emitted during the waste bag emptying phase.



Before starting installation, make sure that the distance between the extraction device and the work areas is sufficient to minimize the risk of inhaling dust emitted during the filter replacement phase.

- For installation, see section "4.2 Instructions for machine assembly".
- For information on installing optional components, see section "4.6 Installing optional accessories".
- It is recommended to install the machine near utility lines and connect it to collection systems using rigid pipes or hoses.
- Place the extraction device in an environment with an operating temperature of +5 °C to +40 °C.
- To reduce sound levels due to reverberation, do not place the extraction device in corners, near walls and ceilings, or on recessed metal structures.

4.5 ELECTRICAL CONNECTION



Use personal protective equipment during assembly.



Use personal protective equipment as specified in the instructions.



Before making electrical connections, verify the correct power source.



The electrical connection must be carried out by qualified personnel. The manufacturer is not responsible for damage to the extraction device or other workshop equipment due to incorrect or unprofessional installation of the device!



Connect the machine to the grounding conductor using a copper braided wire in accordance with the regulations in force in the country in which it is installed.



4.5.1 Connection to the power supply network

The electrical equipment is designed for the following conditions. If operation beyond the conditions described below is required, an assessment must be made to keep the electrical equipment in good and safe operation.

- Ambient air temperature: +5 °C to +40 °C in open air and the average ambient air temperature over a 24-hour period must not exceed +30 °C.
- Humidity: 30 % to 70 %.
- Altitude: up to 1000 m above mean sea level.
- Conditions for transport and storage: -10 °C to +40 °C.

1) Check:

- voltage
- network frequency and phase

The correct data for using the machine are given on the label located on the machine or in the technical data table in the manual.

2) Connect the power supply.

The connection to the electrical network is ensured by a movable supply, inserting the plug into a 400 V, 16 A, 3 ph mains socket.

Connect the motor to the electrical network in accordance with current safety regulations. Before starting the machine, check that it is properly grounded.

Check that the supply voltage and frequency correspond to the specifications on the motor nameplate. Including overvoltage protection. Remember that the calibration current of the thermal or grounding circuit breaker must not exceed the specifications on the nameplate.

Take into account that the current drawn will vary between 50 and 75 % of the specifications on the nameplate when the motor is correctly installed on the machine.



For all optional accessories that require electrical connection, please contact ADAMIK Company technical support office first. See section "4.6 Installing optional accessories".



In the event of a power outage, the operator must turn off the power switch and unplug the power cord from the electrical outlet. Restarting is performed according to the instructions in this user manual.



The workplace must be equipped with an appropriate fire extinguisher.



All maintenance work should be carried out by a qualified person.

4.5.2 Wiring diagram

400 V, 3 phases

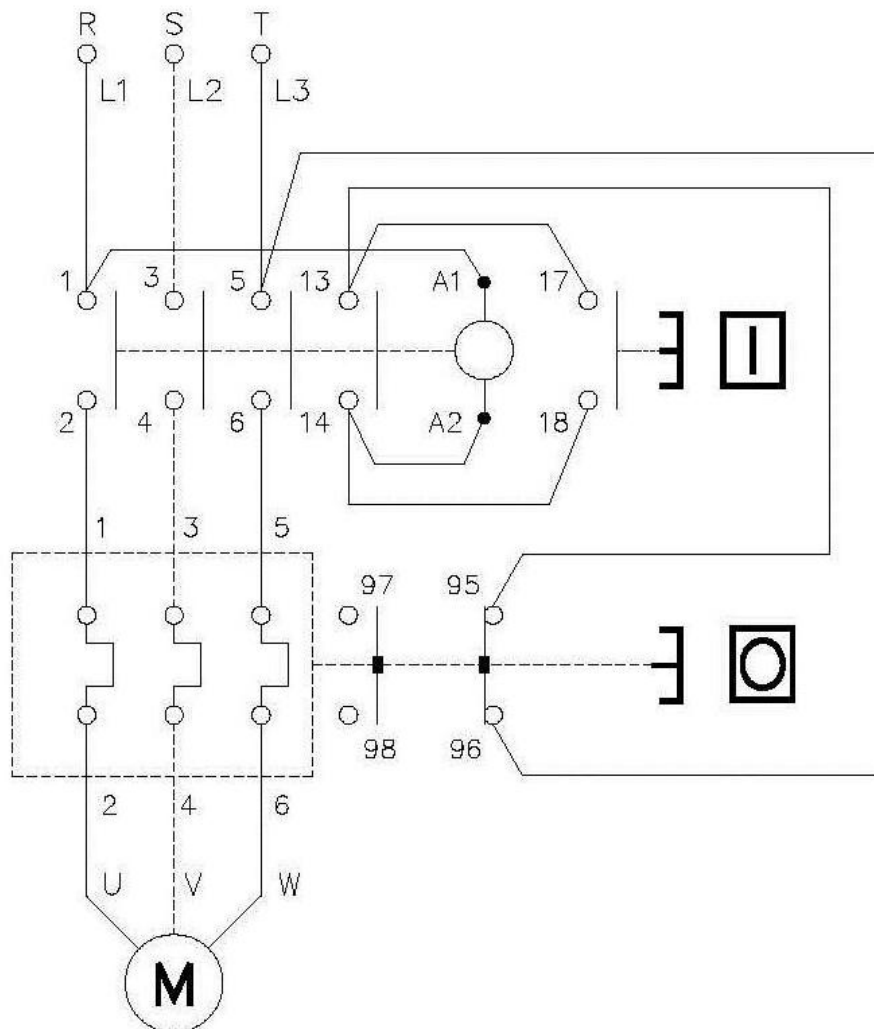

4.6 INSTALLATION OF OPTIONAL ACCESSORIES



Accessories that are difficult to assemble are not described in the instructions. For any information, please contact the ADAMIK Company technical department.

The following optional accessories can be installed on the machine:

- branch or Y-piece
- extraction hose
- ADAMIK automatic start system
- various types of filters and waste bags...

4.7 TEST OPERATION

4.7.1 Starting the machine



Connect the machine to the grounding conductor using a copper braid in accordance with the regulations in force in the country in which it is installed.



Check that the filters and waste bags are installed correctly.



Check the tightening of the screws.



Check the direction of rotation of the ventilator rotor.



Check that the extraction device does not vibrate or make excessive noise.



Check the tightness of the connections of the piping system and the unit. Apply silicone sealant to any leaks *BEFORE STARTING OPERATION*.

Start the extraction device by switching on the switch. After a few seconds of "idle running", start the extracted machine.

Check the motor speed to ensure that the direction of rotation corresponds to the arrow on the motor. After two minutes, stop working on the extracted machine and switch off the extraction device after a short run (a few seconds).

During operation, it is necessary to monitor in particular:



- the correct function of the extraction device and its smooth operation,
- the cleanliness of the machine and its surroundings,
- load the machine according to its label values and check the temperature of the bearings,

5. TECHNICAL INFORMATIONS

5.1 MANUFACTURER AND MACHINE IDENTIFICATION

The manufacturer's identification is indicated on the identification plate and on the declaration of conformity.

The plate indicates the manufacturer's data and the technical data necessary for correct and safe use.

 ADAMIK Company, s.r.o. Mitrovická 804 739 21 Paskov Czech Republic  	TYP / TYPE	
	VÝROBNÍ ČÍSLO / PRODUCTION NO.	
	KAPACITA / CAPACITY	m ³ / h
	PODTLAK / UNDERPRESSURE	Pa
	PŘÍKON / POWER	kW
	ROK VÝROBY / PRODUCTION YEAR	

5.2 DESCRIPTION OF THE MACHINE AND OPERATION CYCLE

The extraction device is made of steel construction, it is equipped with fabric filters and PVC waste bags in the standard version. Clamps are used to attach the filters and waste bags.

The extraction device is designed to extract chips and sawdust with a diameter greater than 0.5 mm.

The extracted material is carried through the pipe distribution to the filter. Separation occurs in the filter, clean air is returned to the working environment, waste is collected in waste bags.



During extraction, the waste bags may be filled unevenly. The filling of waste bags is influenced by the nature of the material, especially its structure and weight, as well as the method of connection to the piping system and other factors.



Waste bags must be emptied at a maximum level of 3/4 full. Overfilling waste bags may damage the extraction device or its parts.



If you notice a decrease in extraction performance with PEA* filters, we recommend cleaning the filters with compressed air.

5.3 TECHNICAL PARAMETERS

5.3.1 Dimensions and weight of the unit – FT 416 series



*The stated extraction capacity can be achieved under optimal conditions. The extraction capacity may vary depending on the type of extracted substance, its concentration, environmental parameters, hours worked, etc.
For the correct filter size setting for the desired application, please contact the ADAMIK Company technical office.*

	Unit	Type	
		FT 416 SF	FT 416 HSF
Motor power	kW	1,5	1,5
Voltage	V	400	400
Extraction capacity (max)	m ³ /h	4 200	4 200
Underpressure (max)	Pa	2 740	2 740
Connection to hose	mm	160	160
Waste bags volume	l	300	300
Noise	dB	79	79
Filtration area	m ²	3	6
Height	mm	2 910	2 770
Width	mm	700	700
Length	mm	1 200	1 200
Weight	kg	87	89

	Unit	Type		
		FT 400 PEA	FT 400 PEAC	FT 400 PEAM
Motor power	kW	1,5	1,5	1,5
Voltage	V	400	400	400
Extraction capacity (max)	m ³ /h	4 200	4 200	4 200
Underpressure (max)	Pa	2 740	2 740	2 740
Connection to hose	mm	160	160	160
Waste bags volume	l	300	300	300
Noise	dB	79	79	79
Filtration area	m ²	12	12	12
Height	mm	2 250	2 460	2 430
Width	mm	700	700	700
Length	mm	1 200	1 200	1 200
Weight	kg	100	104	105

5.3.2 Dimensions and weight of the unit – FT 420 series



The stated extraction capacity can be achieved under optimal conditions. The extraction capacity may vary depending on the type of extracted substance, its concentration, environmental parameters, hours worked, etc. For the correct filter size setting for the desired application, please contact the ADAMIK Company technical office.

	Unit	Type	
		FT 420 SF	FT 420 HSF
Motor power	kW	2,2	2,2
Voltage	V	400	400
Extraction capacity (max)	m ³ /h	5 940	5 940
Underpressure (max)	Pa	2 490	2 490
Connection to hose	mm	200	200
Waste bags volume	l	300	300
Noise	dB	84	84
Filtration area	m ²	3	6
Height	mm	2 910	2 770
Width	mm	700	700
Length	mm	1 200	1 200
Weight	kg	93	95

	Unit	Type		
		FT 420 PEA	FT 420 PEAC	FT 420 PEAM
Motor power	kW	2,2	2,2	2,2
Voltage	V	400	400	400
Extraction capacity (max)	m ³ /h	5 940	5 940	5 940
Underpressure (max)	Pa	2 490	2 490	2 490
Connection to hose	mm	200	200	200
Waste bags volume	l	300	300	300
Noise	dB	84	84	84
Filtration area	m ²	12	12	12
Height	mm	2 250	2 460	2 430
Width	mm	700	700	700
Length	mm	1 200	1 200	1 200
Weight	kg	106	110	111

5.3.3 Dimensions and weight of the unit – FT 440 series



The stated extraction capacity can be achieved under optimal conditions. The extraction capacity may vary depending on the type of extracted substance, its concentration, environmental parameters, hours worked, etc. For the correct filter size setting for the desired application, please contact the ADAMIK Company technical office.

	Unit	Type	
		FT 440 SF	FT 440 HSF
Motor power	kW	3,7	3,7
Voltage	V	400	400
Extraction capacity (max)	m ³ /h	9 600	9 600
Underpressure (max)	Pa	2 930	2 930
Connection to hose	mm	250	250
Waste bags volume	l	600	600
Noise	dB	82	82
Filtration area	m ²	6	12
Height	mm	2 910	2 770
Width	mm	742	742
Length	mm	2 000	2 000
Weight	kg	133	138

	Unit	Type		
		FT 440 PEA	FT 440 PEAC	FT 440 PEAM
Motor power	kW	3,7	3,7	3,7
Voltage	V	400	400	400
Extraction capacity (max)	m ³ /h	9 600	9 600	9 600
Underpressure (max)	Pa	2 930	2 930	2 930
Connection to hose	mm	250	250	250
Waste bags volume	l	600	600	600
Noise	dB	82	82	82
Filtration area	m ²	12	12	12
Height	mm	2 250	2 460	2 430
Width	mm	742	742	742
Length	mm	2 250	2 250	2 250
Weight	kg	160	168	170

5.3.4 Noise



To reduce noise levels due to reverberation, we do not recommend installing the extractor near corners, walls or over metal boxes.



WARNING!!

Check the legislative requirements in force in the country of installation and, if necessary, use:

- **Personal protective equipment**
- **Any soundproofing screens**

5.3.5 Delivery contents – FT 416 series

Nr. of pieces in the variant	FT 416 SF	FT 416 VSF	FT 416 HSF	FT 416 VHSF
Body	1	1	1	1
Stand – legs	4	4	4	4
Wheel with brake	2	2	2	2
Standard wheel	2	2	2	2
Motor	1	1	1	1
Standard filter	1	1	-	-
Hose filter	-	-	1	1
PVC waste bag	3	-	3	-
Textile waste bag	-	1	-	1
Clamp	2	2	2	2
Filter holder	1	1	1	1
Assembly kit (screws, washers, nuts...)	1	1	1	1

Nr. of pieces in the variant	FT 416 PEA	FT 416 PEAC	FT 416 PEAM
Body	1	1	1
Stand – legs	4	4	4
Wheel with brake	2	2	2
Standard wheel	2	2	2
Motor	1	1	1
Cartridge filter FPEA	1	-	-
Cartridge filter FPEAC	-	1	-
Cartridge filter FPEAM	-	-	1
PVC waste bag	3	3	3
Clamp	2	2	2
Filter holder	1	1	1
Assembly kit (screws, washers, nuts...)	1	1	1

Nr. of pieces in the variant	FT 416 VPEA	FT 416 VPEAC	FT 416 VPEAM
Body	1	1	1
Stand – legs	4	4	4
Wheel with brake	2	2	2
Standard wheel	2	2	2
Motor	1	1	1
Cartridge filter FPEA	1	-	-
Cartridge filter FPEAC	-	1	-
Cartridge filter FPEAM	-	-	1
Textile waste bag	1	1	1
Clamp	2	2	2
Filter holder	1	1	1
Assembly kit (screws, washers, nuts...)	1	1	1

5.3.6 Delivery contents – FT 420 series

Nr. of pieces in the variant	FT 420 SF	FT 420 VSF	FT 420 HSF	FT 420 VHSF
Body	1	1	1	1
Stand – legs	4	4	4	4
Wheel with brake	2	2	2	2
Standard wheel	2	2	2	2
Motor	1	1	1	1
Standard filter	1	1	-	-
Hose filter	-	-	1	1
PVC waste bag	3	-	3	-
Textile waste bag	-	1	-	1
Clamp	2	2	2	2
Filter holder	1	1	1	1
Assembly kit (screws, washers, nuts...)	1	1	1	1

Nr. of pieces in the variant	FT 420 PEA	FT 420 PEAC	FT 420 PEAM
Body	1	1	1
Stand – legs	4	4	4
Wheel with brake	2	2	2
Standard wheel	2	2	2
Motor	1	1	1
Cartridge filter FPEA	1	-	-
Cartridge filter FPEAC	-	1	-
Cartridge filter FPEAM	-	-	1
PVC waste bag	3	3	3
Clamp	1	1	1
Filter holder	1	1	1
Assembly kit (screws, washers, nuts...)	1	1	1

Nr. of pieces in the variant	FT 420 VPEA	FT 420 VPEAC	FT 420 VPEAM
Body	1	1	1
Stand – legs	4	4	4
Wheel with brake	2	2	2
Standard wheel	2	2	2
Motor	1	1	1
Cartridge filter FPEA	1	-	-
Cartridge filter FPEAC	-	1	-
Cartridge filter FPEAM	-	-	1
Textile waste bag	1	1	1
Clamp	1	1	1
Filter holder	1	1	1
Assembly kit (screws, washers, nuts...)	1	1	1

5.3.7 Delivery contents – FT 440 series

Nr. of pieces in the variant	FT 440 SF	FT 440 VSF	FT 440 HSF	FT 440 VHSF
Body	1	1	1	1
Stand – legs	4	4	4	4
Wheel with brake	2	2	2	2
Standard wheel	2	2	2	2
Motor	1	1	1	1
Standard filter	2	2	-	-
Hose filter	-	-	2	2
PVC waste bag	6	-	6	-
Textile waste bag	-	2	-	2
Clamp	4	4	4	4
Filter holder	2	2	2	2
Assembly kit (screws, washers, nuts...)	1	1	1	1

Nr. of pieces in the variant	FT 440 PEA	FT 440 PEAC	FT 440 PEAM
Body	1	1	1
Stand – legs	4	4	4
Wheel with brake	2	2	2
Standard wheel	2	2	2
Motor	1	1	1
Cartridge filter FPEA	2	-	-
Cartridge filter FPEAC	-	2	-
Cartridge filter FPEAM	-	-	2
PVC waste bag	6	6	6
Clamp	4	4	4
Filter holder	2	2	2
Assembly kit (screws, washers, nuts...)	1	1	1

Nr. of pieces in the variant	FT 440 VPEA	FT 440 VPEAC	FT 440 VPEAM
Body	1	1	1
Stand – legs	4	4	4
Wheel with brake	2	2	2
Standard wheel	2	2	2
Motor	1	1	1
Cartridge filter FPEA	2	-	-
Cartridge filter FPEAC	-	2	-
Cartridge filter FPEAM	-	-	2
Textile waste bag	2	2	2
Clamp	4	4	4
Filter holder	2	2	2
Assembly kit (screws, washers, nuts...)	1	1	1

5.4 DESCRIPTION OF SAFETY DEVICE

The machine is originally equipped with the protective systems necessary for working in safe conditions. In the case of connection to other machines, the end user is responsible for evaluating the associated risks.

5.5 PERIMETER AREAS



When installing, pay attention to the necessary overall dimensions required for machine maintenance.



When installing, take into account the dimensions of any optional parts and accessories.



When installing, take into account the dimensions of the waste Bags and filters to allow for their removal and reinsertion into the machine.

When installing, ensure that there is enough space for the machine to operate at full capacity. (See section "5.3.1 Dimensions and weight of the unit").

Minimum area required for the machines to be placed – FT 416 series: 1 700 x 1 310 mm.

Minimum area required for the machines to be placed – FT 420 series: 1 700 x 1 310 mm.

Minimum area required for the machines to be placed – FT 440 series: 2 500 x 1 360 mm.

6. INFORMATIONS FOR USE

6.1 RECOMMENDATIONS FOR USE



The machine is designed for operation under pressure.



The use of flammable sprays, abrasive grinders, or other tools that can create sparks or open flames during welding can cause the filter fabric waste bag fabric to ignite.



The machine is designed for operation in an environment protected from atmospheric weather.



***The machine is designed to operate at an ambient temperature between +5 °C and +40 °C.
It is recommended to use an operating temperature not higher than 40 °C.***



***Any other use of the machine must be approved in advance by ADAMIK Company.
If the user does not have written authorization, the manufacturer and supplier refuse any liability for damage to persons or property, and the warranty on the line and machinery will also expire.***

6.2 CORRECT USE / IMPROPER USE

6.2.1 Type of extracted material

SUITABLE FOR EXTRACTING:

- Wood dust
- Small chips
- Sawdust
- Dry chips and dust without moisture

UNSUITABLE FOR EXTRACTING:

- Wet materials, liquids
- Working in an environment where there is a risk of explosion
- Flammable or explosive vapors
- Potentially explosive metal powder
- Metal powder
- Powder that may be explosive by its nature or reaction.
- Material that can cause sparks and incandescent material

WORKING ENVIRONMENT:

- Material originating from processing operations in the wood industry.

6.3 IN THE CASE OF FIRE



Before proceeding, ensure that the procedure is carried out safely and using the correct means according to the company's emergency and evacuation plan.



Burning produces gases that can be hazardous to health if inhaled. The gases continue to be produced even after the flames have been extinguished.



The workplace must be equipped with the appropriate fire extinguisher.

- 1) Stop the machine, disconnect the power
- 2) Contact the fire department.
- 3) If conditions are safe, use a portable fire extinguisher (min. class AB) over 6 kg and try to smother the fire.

7. MAINTENANCE

7.1 MAINTENANCE RECOMMENDATIONS



Carefully read the instructions in this manual before performing any maintenance.



Perform maintenance activities using the personal protective equipment described in the manual.

Do not perform any maintenance while the machine is in operation or connected to a power source.



Before any maintenance or repair work:

- **Switch off the machine.**
- **Disconnect the power source.**
- **Empty the waste collection bags.**



Do not use flammable liquids when cleaning the filter unit.



Always wear suitable footwear to prevent electrostatic discharge before performing any maintenance intervention.



To avoid the risk of fire or explosion, never smoke or use an open flame inside or near the extraction unit during maintenance or cleaning.



To avoid the risk of fire or explosion, never use mobile phones or other similar devices inside or near the extraction unit during maintenance or cleaning.



Empty waste collection bags regularly before they reach their maximum level to avoid handling heavy overfilled bags.



Always clean the filter bag after the end of the shift and empty the waste bag as needed.



During extraction, the waste bags may be filled unevenly. The filling of the waste bags is influenced by the nature of the material, especially its structure and weight, as well as the method of connection to the pipe system. The waste bags must be emptied at a maximum level of 3/4 full. Overfilling the waste bags may lead to damage to the extraction device or its parts.



If you notice a decrease in suction power with cartridge PEA* filters (if equipped), we recommend cleaning the filters with compressed air.



The device is designed for operation with a maximum number of EIGHT on/off cycles per shift (= 8 hours of operation).



***When operating the device, it is necessary to ensure the minimum allowed amount of air flow, depending on the fan.
Never operate the extraction device if the minimum air flow is not ensured or if all shutters are deactivated (in the closed position).***



After the end of the work cycle, gradually open the relevant shutters so that the extraction device runs at maximum power and the pipes are cleaned.



Switching the summer/winter operation (mode) of the flaps (if equipped) and their control must only be performed when the fan and extraction device are turned off.

7.2 EMPTYING THE WASTE BAGS

- Switch off the extraction device.
- Wait for about 1 minute until the dust has settled.
- Loosen the clamp.
- Remove the waste bag from the extraction unit and carry it outside the workshop.
- Pour the contents of the waste bag into a waste container or a polyethylene bag. Care must be taken to avoid scattering the waste.
- Attach the emptied waste bag back to the extraction device using the clamp.



***Waste bags must be installed correctly. Incorrect installation of the waste bags can lead to leaks. A waste bag that shows signs of leakage even when installed correctly should be replaced.
If a disposable PVC bag is used, a simple waste bag change is required.***



***Never wash waste bags in the washing machine!
Never dry waste bags in the dryer!
There is a risk of damage to the waste bags and the appliance!***

7.3 CLEANING THE FILTERS

- Preventively tap the outer surface of the filter after each shift.
- Vacuum clean the inside of the filter.
- Use a cleaning device (versions *PEAC, *PEAM)
- If the filter cleaning intervals become shorter, the filter must be replaced.



Filters must be installed correctly. Incorrect installation of filters can lead to leaks. A filter that shows signs of leakage even when installed correctly must be replaced.



***Never wash filters in a washing machine!
Never dry filters in a dryer!
There is a risk of damage to the filters and the appliance!***

7.4 TABLE OF SCHEDULED MAINTENANCE INTERVALS



It is recommended to keep a maintenance register to preserve the history of the interventions carried out.

Routine maintenance operations should be performed at the interval shown in the table below.

Operation / Check interval	Very often	Often		Occasionally	
	24 hrs	250 hrs	500 hrs	1 000 hrs	1 500 hrs
Check that the filtration efficiency is sufficient.	X				
Check and replace if necessary filters with tears or abrasions.			X		
Check the condition of the power cables.				X	
Check the filling level of the collection waste bags.	X				
Check the piping system for clogging and the cleanliness of the shutters (if equipped).		X			
Check the extraction device for vibrations or excessive noise.		X			



Regularly empty collection waste bags before they reach the maximum level to avoid handling heavy weight.

7.5 CLEANING AND DISPOSAL



Perform maintenance activities using the personal protective equipment described in the manual.



Improper cleaning or insufficient replacement of filters can cause contamination to escape into the environment and/or workplace.



Used filters and dust must be stored and disposed of in accordance with the laws in force in the country where the machine is used.



Do not disperse polluting material into the environment. Place the used filters in the protective packaging. Seal the package.



After removing the filters, it is necessary to remove the residual dust on the base of the machine and on the upper attachment of the filters. For proper cleaning of the machine, use an industrial vacuum cleaner with suitable filtration efficiency according to the type of dust being processed.

8. TROUBLESHOOTING



The following information is intended to help identify anomalies and restore machine operation and efficiency.

Defect	Cause	Possible solutions
The air at the filter unit outlet is not clean enough.	Insufficient efficiency of filters.	Check for cleanliness and remove or replace any parts as necessary.
	The amount and type of dust do not match those in the project.	Rework the project and replace the filter unit.
	The type of filter does not match the type of dust to be extracted.	Rework the project and replace the filter unit.
	Broken or torn filter elements.	Continue to remove and replace them.
Reduction of the exhaust air flow rate.	Filters are not clean.	Remove and clean the filters. If necessary, replace the filters with new ones.
	The connected pipe is clogged.	Remove obstacles.
After a certain period of time when the machine is working properly, dust will begin to be released into the environment.	Broken or torn filter elements.	Continue to remove and replace them.
	Error in fixing filter elements.	Continue with proper fixing. Proceed with the replace them.
	Broken or torn waste bags.	
	An error in the fastening of the collection waste bags.	

9. PARTS REPLACEMENT INFORMATIONS

9.1 ORDERING SPARE PARTS AND ACCESSORIES

If you need to order spare parts or any accessories, please proceed as follows:

1. Look for the machine type and machine serial number - both can be found on the serial plate.
2. If possible, find the sales invoice number.
3. Contact the sales representative from whom you purchased the machine or directly ADAMIK

Company at the following contacts:

Email: info@adamikcompany.com

Phone: +420 774 883 858

9.2 RECOMMENDATIONS FOR REPLACEMENT OF SPARE PARTS



Read section "7 Maintenance" before any replacement.



Machine replacement or repair operations are reserved for qualified, trained and authorized personnel employed by the manufacturer or an authorized dealer.



Replace the filters using the protective equipment described in the instructions.



Turn off the machine and disconnect all electrical sources.



To avoid the risk of fire or explosion, never smoke or use an open flame inside or near the filter unit during maintenance or cleaning.



To avoid the risk of fire or explosion, never use mobile phones or other similar devices inside or near the filter unit during maintenance or cleaning.



When replacing the filter elements, pay special attention to handling due to the high incidence of potentially explosive dust.



Filters covered with dust must be stored in suitable closed containers and disposed of in accordance with the regulations in force in the country of installation.



**After removing the filters, it is necessary to remove residual dust from the base of the machine and from the space for hanging the filters.
For proper internal cleaning of the machine, use an industrial vacuum cleaner with suitable filtration efficiency according to the type of dust being processed.**

9.3 LIST OF REPLACEABLE PARTS

9.3.1 FT 416 series

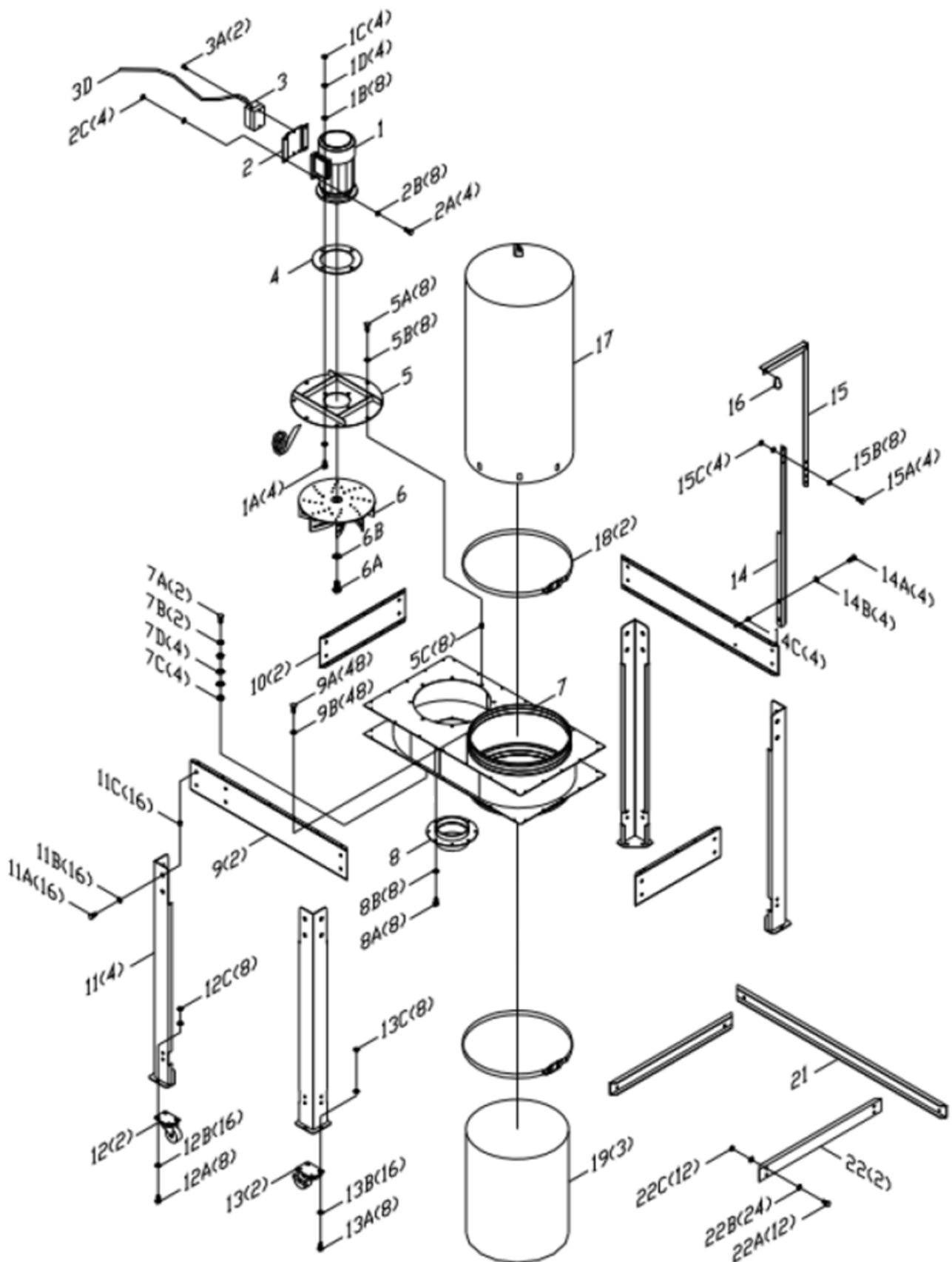

Part nr.	Description	Pcs.
1	MOTOR	1
1A	HEX SCREW	4
1B	FLAT WASHER	8
1C	HEX NUT	4
1D	SPRING WASHER	4
2	SWITCH BASE	1
2A	HEX SCREW	4
2B	FLAT WASHER	8
2C	HEX NUT	4
3	CONJUNCTION BOX	1
3A	IRON PHILLIP SCREW	2
3D	MOTOR WIRE	1
4	MOTOR GASKET	1
5	MOTOR BASE	1
5A	HEX SCREW	8
5B	FLAT WASHER	8
5C	NUT	8
6	IMPELLER	1
6A	MOTOR SCREW	1
6B	MOTOR SPECIAL WASHER	1
7	BLOWER	1
8	HEX COPPER SCREW	1
8A	FLAT WASHER	8
8B	HEX COPPER NUT	8
9	TOOTHED WASHER	2
9A	INLET DISC CONNECTOR	48
9B	HEX SCREW	48
10	FLAT WASHER	2
11	BLOWER LONG SIDEBBOARD	4
11A	HEX SCREW	16
11B	FLAT WASHER	16
11C	BLOWER SHORT SIDEBBOARD	16
12	RUBBER CASTER	2
12A	HEX SCREW	8
12B	FLAT WASHER	16
12C	HEX NUT	8
13	RUBBER CASTER	2
13A	HEX SCREW	8

Part nr.	Description	Pcs.
13B	FLAT WASHER	16
13C	HEX NUT	8
14	LOWER HANGER	1
14A	HEX SCREW	4
14B	FLAT WASHER	4
14C	NUT	4
15	UPPER HANGER	1
13B	HEX SCREW	16
13C	FLAT WASHER	8
14	HEX NUT	1
14A	HOOK	4
14B	FLAT WASHER	4
14C	HEX NUT	4
15	LOWER HANGER	1
15A	HEX SCREW	4
15B	FLAT WASHER	8
15C	NUT	4
16	UPPER HANGER	1
17	FILTER - F610/FT420 (version SF, VSF) - F610H (version HSF, VHSF) - FPEA-610-12 (version PEA, VPEA) - FPEAC-610-12 (version PEAC, VPEAC) - FPEAM-610-12 (version PEAM, VPEAM)	1 1 1 1 1
18	CLAMP UP610	2
19	WASTE BAG - V610PVC (version SF, HSF, PEA, PEAC, PEAM) - V610FTEX (version VSF, VHSF, VPEA, VPEAC, VPEAM) - V610STR (reinforced PE bag, optional)	1 1 1
20	HOSE CLAMP	1
15A	STAND BAR (LONG)	4
15B	STAND BAR (SHORT)	8
15C	HEX SCREW	4
16	FLAT WASHER	1

9.3.2 FT 420 series

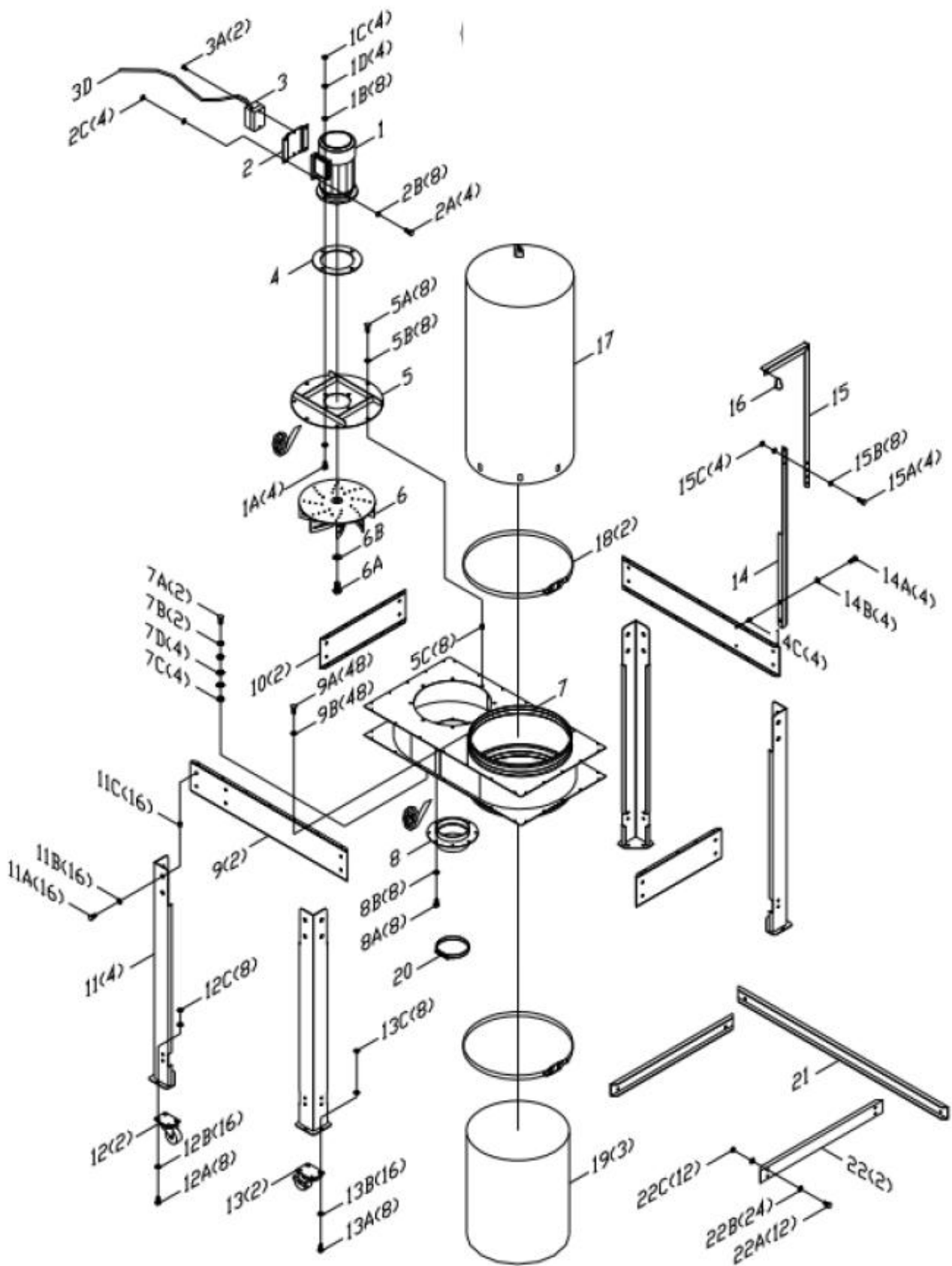

Part nr.	Description	Pcs.
1	MOTOR	1
1A	HEX SCREW	4
1B	FLAT WASHER	8
1C	HEX NUT	4
1D	SPRING WASHER	4
2	SWITCH BASE	1
2A	HEX SCREW	4
2B	FLAT WASHER	8
2C	HEX NUT	4
3	CONJUNCTION BOX	1
3A	IRON PHILLIP SCREW	2
3D	MOTOR WIRE	1
4	MOTOR GASKET	1
5	MOTOR BASE	1
5A	HEX SCREW	8
5B	FLAT WASHER	8
5C	NUT	8
6	IMPELLER	1
6A	MOTOR SCREW	1
6B	MOTOR SPECIAL WASHER	1
7	BLOWER	1
8	HEX COPPER SCREW	1
8A	FLAT WASHER	8
8B	HEX COPPER NUT	8
9	TOOTHED WASHER	2
9A	INLET DISC CONNECTOR	48
9B	HEX SCREW	48
10	FLAT WASHER	2
11	BLOWER LONG SIDEBOARD	4
11A	HEX SCREW	16
11B	FLAT WASHER	16
11C	NUT	16
12	RUBBER CASTER	2
12A	HEX SCREW	8
12B	FLAT WASHER	16
12C	HEX NUT	8
13	RUBBER CASTER	2
13A	HEX SCREW	8

Part nr.	Description	Pcs.
13B	FLAT WASHER	16
13C	HEX NUT	8
14	LOWER HANGER	1
14A	HEX SCREW	4
14B	FLAT WASHER	4
14C	NUT	4
15	UPPER HANGER	1
15A	HEX SCREW	16
15B	FLAT WASHER	8
15C	HEX NUT	1
16	HOOK	4
17	FILTER	
	- F610/FT420 (version SF, VSF)	1
	- F610H (version HSF, VHSF)	1
	- FPEA-610-12 (version PEA, VPEA)	1
	- FPEAC-610-12 (version PEAC, VPEAC)	1
	- FPEAM-610-12 (version PEAM, VPEAM)	1
18	CLAMP UP610	2
19	WASTE BAG	
	- V610PVC (version SF, HSF, PEA, PEAC, PEAM)	1
	- V610FTEX (version VSF, VHSF, VPEA, VPEAC, VPEAM)	1
	- V610STR (reinforced PE bag, optional)	1
20	HOSE CLAMP	1
21	STAND BAR (LONG)	1
22	STAND BAR (SHORT)	2
22A	HEX SCREW	12
22B	FLAT WASHER	24
22C	NUT	12

9.3.3 FT 440 series

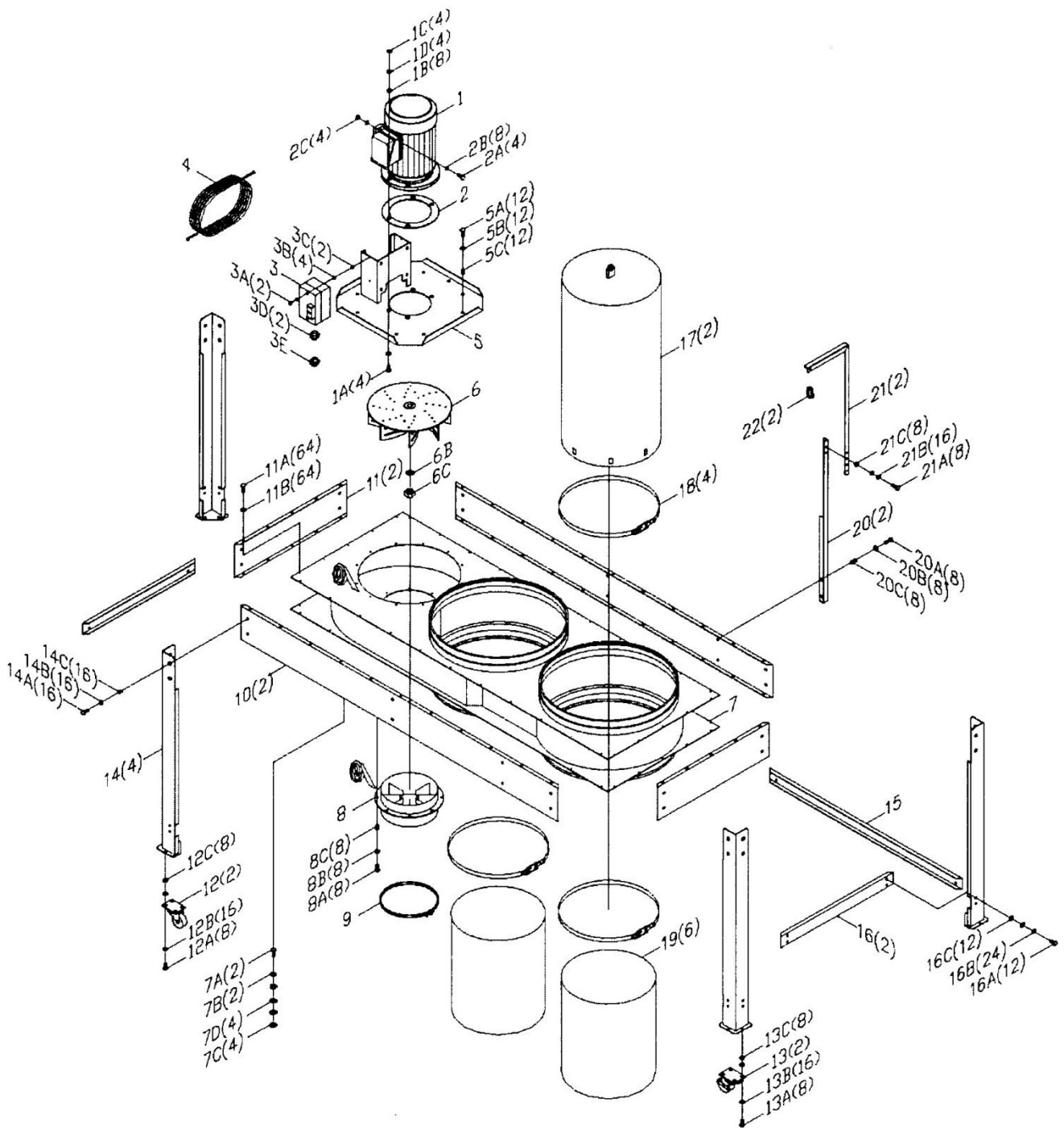

Part nr.	Description	Pcs.
1	MOTOR	1
1A	HEX SCREW	4
1B	FLAT WASHER	8
1C	HEX NUT	4
1D	SPRING WASHER	4
2	SWITCH BASE	1
2A	HEX SCREW	4
2B	FLAT WASHER	8
2C	HEX NUT	4
2D	WASHER	4
3	CONJUNCTION BOX	1
3A	IRON PHILLIP SCREW	2
3B	FLAT WASHER	4
3C	NUT	2
3D	POWER CORD	1
3E	POWER CORD	1
4	MOTOR GASKET	1
5	MOTOR BASE	1
5A	HEX SCREW	12
5B	FLAT WASHER	12
5C	NUT	12
6	IMPELLER 17"	1
6B	MOTOR SCREW	1
6C	MOTOR SPECIAL WASHER	1
7	BLOWER	1
7A	HEX COPPER SCREW	2
7B	FLAT WASHER	2
7C	HEX COPPER NUT	2
7D	TOOTHED WASHER	2
8	INLET DISC CONNECTOR	1
8A	HEX SCREW	8
8B	FLAT WASHER	8
8C	NUT	8
9	HOSE CLAMP	1
10	BLOWER LONG SIDEBOARD	2
11	BLOWER SHORT SIDEBOARD	2
11A	HEX SCREW	64
11B	FLAT WASHER	64

Part nr.	Description	Pcs.
12	RUBBER CASTER	2
12A	HEX SCREW	8
12B	FLAT WASHER	16
12C	HEX NUT	8
13	RUBBER CASTER	2
13A	HEX SCREW	8
13B	FLAT WASHER	16
13C	HEX NUT	8
14	LOWER HANGER	4
14A	HEX SCREW	16
14B	FLAT WASHER	16
14C	NUT	16
15	STAND BAR (LONG)	1
16	STAND BAR (SHORT)	2
16A	HEX SCREW	12
16B	FLAT WASHER	24
16C	NUT	12
17	FILTER	
	- F610/FT420 (version SF, VSF)	2
	- F610H (version HSF, VHSF)	2
	- FPEA-610-12 (version PEA, VPEA)	2
	- FPEAC-610-12 (version PEAC, VPEAC)	2
	- FPEAM-610-12 (version PEAM, VPEAM)	2
18	CLAMP UP610	2
19	WASTE BAG	
	- V610PVC (version SF, HSF, PEA, PEAC, PEAM)	2
	- V610FTEX (version VSF, VHSF, VPEA*)	2
	- V610STR (reinforced PE bag, optional)	2
20	LOWER FILTER HANGER	2
20A	HEX SCREW	8
20B	FLAT WASHER	8
20C	NUT	8
21	UPPER FILTER HANGER	2
21A	HEX SCREW	8
21B	FLAT WASHER	16
21C	NUT	8
22	HOOK	2

9.4 OPTIONAL EQUIPMENT





























**All optional equipment must be approved by the manufacturer.
Use personal protective equipment during installation.**

Accessories that are difficult to assemble are not described in the instructions. For any information contact ADAMIK Company directly.

9.5 DECOMMISSIONING

The machine does not present any particular problems for decommissioning. Care must be taken to prevent unauthorized persons from starting the machine.

Comply with the laws in force in the country of use for any legal and tax aspects (any reports, complaints, etc.).

Component	Material	Treatment	Note
Unit construction	Steel	 RECYCLABLE STEEL	  
Standard and hose filters	Polyester		Place clogged filters in a sealed protective package. Information on the correct disposal of these items can be found in the current valid regulations of your state.
		 	    Place clogged filters in a sealed protective package. Information on the correct disposal of these items can be found in the current valid regulations of your state.
Electrical controls and components	OEEZ		Information on the correct disposal of these items can be found in the currently valid regulations of the country where the machine is installed.
Waste bags textile	Polyester		Place clogged waste bags in sealed protective packaging. Information on the correct disposal of these items can be found in the current valid regulations of your state.
		 	    Place clogged waste bags in sealed protective packaging. Information on the correct disposal of these items can be found in the current valid regulations of your state.
PVC, PE waste bags	PVC, PE		Place clogged waste bags in sealed protective packaging. Information on the correct disposal of these items can be found in the current valid regulations of your state.
		 	    Place clogged waste bags in sealed protective packaging. Information on the correct disposal of these items can be found in the current valid regulations of your state.



SPECIAL WASTE.

Use appropriate protection to avoid contact with particles that may have been released. Information on the correct disposal of these items can be found in the current applicable regulations.



STEEL.

Fully recyclable.



NON-RECYCLEABLE MATERIAL.

Take to the appropriate landfill / collection facility.



RECYCLABLE MATERIAL.

Fully recyclable.



WEEZ.

Information on the correct disposal of these items can be found in the current applicable regulations.

10. AUTOMATIC START WITH MACHINE (if equipped)

This extractor can be equipped with an automatic start with the machine (external start system).

This installation can only be carried out by the manufacturer of the appliance, ADAMIK Company, when selling a new appliance.

If you wish to install this appliance afterwards, the extractor must be delivered to an ADAMIK Company service centre.

If your extraction device is equipped with an automatic start with the machine to be extracted, connect the cables as shown in the figure below:



- **Position “MAN” – Manual start mode**

Turn the switch to the left to the “MAN” position - the extraction device is turned on/off by pressing the buttons on the switch. Turn to the central position “0” to turn off the extraction device.

- **Position “0” – Off**

When the switch is in the “0” position, the extraction device is turned off.

- **Position “AUT” – Automatic start mode**

Turn the switch to the right to the “AUT” position - the extraction device switches to automatic mode. In this mode, the extraction device is automatically switched on when the work process of the connected machine is started.

The automatic start mode is ended by turning off the connected machine or turning the switch to the central position “0”.



Cables leading from the machine to the electrical power source must be located and protected in accordance with currently applicable safety regulations and laws.



Verify proper power source before making electrical connections.



Electrical connections must be made by qualified personnel.



In the event of a power failure, the operator must turn off the power switch and unplug the extraction device from the electrical outlet. Restarting is performed according to the instructions in this operating manual.



There is a voltage (phase) on the outlet from the machine (on the automatic start system cable leading from the main switch) that starts the extraction when connected. For this reason, the end of the cable is equipped with a protective box with a warning label.

The cable must be connected to a voltage-free contact in the extracted machine (relay, contactor, manual switch, etc.).

The automatic start system cable is secured by a fuse located on the main switch box of the extraction device.

11. ATTACHMENT OF POLYESTER FILTERS FPEA/ FPEAC/FPEAM (if equipped)

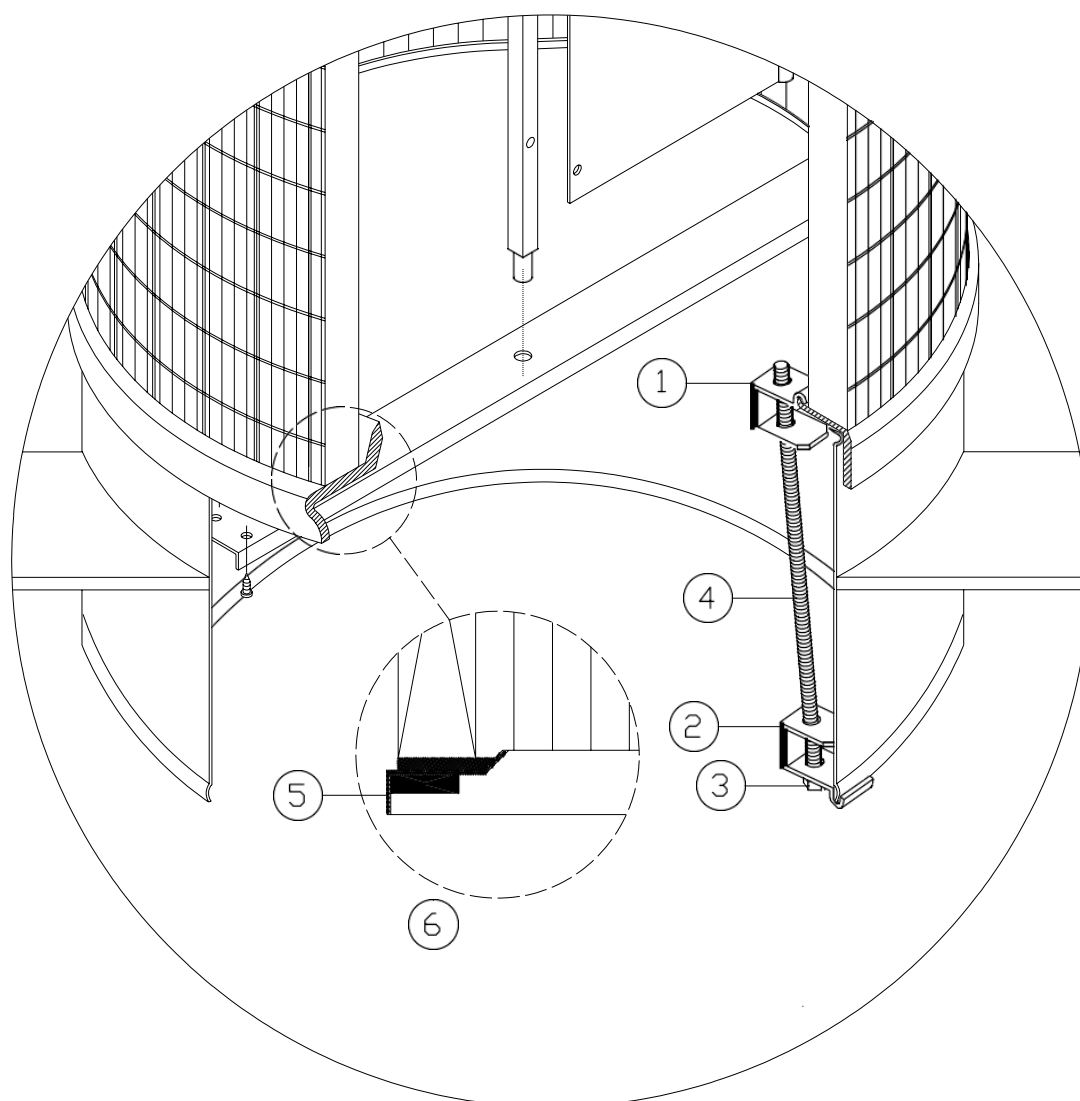

Place the 410/510 mm reduction on the upper circular segment of the extraction device body and seal the joint perfectly.

Place the three supplied brackets (1) on the edge of the metal flange of the filter and the part (2) on the lower edge of the body. Tighten the M6 nut (3) firmly.

Repeat the procedure for all the brackets.

Note: If the circular segment on the machine is lower, shorten the length of the threaded rod (4).

(5) Metal flange

(6) Rubber seal



In case of leaks, seal the joint between the filter and the circular segment with sealing tape.

12. MOTORIZED FILTER CLEANING CONTROL (if equipped)

This extraction device can be equipped with motorized cleaning control of polyester filters.



MOTORIZED FILTER CLEANING CONTROL SWITCH

Position „VYP“ / „OFF“

The power supply for the filter cleaning control is switched off.

Position „ZAP“ / „ON“

I) When the switch is turned to the “ON” („ZAP“) position, the motorized filter cleaning is switched on, it operates for the set time, after which it automatically switches off.

II) When the switch is in the “ON” („ZAP“) position and the extraction device is switched on, after the extraction device is switched off, the motorized filter cleaning is switched on, it operates for the set time, after which it automatically switches off.



typ A typ B

SETTING THE CLEANING TIME

The value is set by the manufacturer to the recommended cleaning time.

The preset value can be changed using a small flat screwdriver.

To extend the interval, turn slightly clockwise.

To shorten the interval, turn slightly counterclockwise.



VARIANT WITH AUTOMATIC START SYSTEM (if equipped)

The switch is located directly on the main switch of the extractor device.

Position „MAN“

After turning the switch to the “MAN” position, the machine can be operated manually by pressing the “ON” and “OFF” buttons on the main switch of the extraction device.

In the same way, the power supply for the motorized filter cleaning control is turned on - see the control above.

Position “0“

When the switch is in the “0” position, the extraction is switched off.

Position “AUT” - Automatic start mode

Turn the switch to the right to the “AUT” position - the extraction switches to automatic mode. In this mode, the extraction device is automatically switched on when the work process of the connected machine starts.

By turning it to the central “0” position, you end the automatic start mode.

13. WARRANTY

The warranty period is 12 months from the date of sale.

The warranty does not apply to defects resulting from improper handling or use for purposes other than those specified in the operating instructions.

13.1 LIABILITY FOR DEFECTS

By law, the manufacturer is liable under the contracts for consideration (purchase, work, etc.) for the fact that the goods or performance at the time of delivery are free of defects. Liability applies to all parts (except point 13.3) as well as to labor, transport and travel costs. Any consequential damages are excluded.

Consumer buyer - legal liability for defects for a period of 2 years from the date of issue of the sales document.

Buyer entrepreneur - pays liability for defects for 6 months from the date of issue of the sales document. In single shift operation.

Additional arrangements always require written form, oral promises are not valid.

13.2 VOLUNTARY ADDITIONAL WARRANTY

Compared to the statutory liability for defects, a voluntary additional guarantee is a voluntary undertaking that the goods or performance beyond the statutory liability for defects will remain free of defects for a certain period of time. The guarantee requires a written form. Oral agreements are excluded. The warranty only applies to mechanical parts (with the exception of point 13.3), it does not apply to labor, transport and travel costs. Any consequential damages are excluded.

The seller provides a **warranty for a period of 12 months or a maximum of 1600 operating hours for parts of mechanical components** (except point 13.3).

The seller provides a **warranty for 6 months for spare parts** (except point 13.3).

In the case of used goods, only the statutory provisions on liability for defects apply, which is 1 year for the consumer buyer and 3 months for the entrepreneur buyer.

13.3 EXCLUSIONS FROM LIABILITY FOR DEFECTS AND FROM WARRANTY

- If the defect did not occur at the time of delivery.
- In case of damage to the goods during transport (these damages must be resolved with the shipping company upon receipt, all shipments are sent insured).
- Defects caused by improper use or overloading (classification of hobby use, craftsman, professional, industrial).
- Defects caused by unprofessional installation, unprofessional commissioning, unprofessional handling, operation or storage or neglect of care of the goods.
- If the prescribed operating or installation conditions are not observed (main board of the machine, electrical distribution, compressed air distribution, exhaust distribution).
- If a defect has occurred due to improper handling or external forces (eg. scratches, dents, twists, etc.).
- No liability is accepted for all consequential damages (such as unforeseeable damages).

- No liability is accepted for wear related to the appearance and as a result of everyday use (eg. paint damage, scratches, etc.).
- Does not accept responsibility for any defects caused by pollution.
- No liability is accepted for defects caused by non-compliance with the instructions in the operating instructions or maintenance instructions or arising from use that is in conflict with the operating instructions or normal use.
- No liability is accepted for consumable parts (eg. bearings, belts, gears, segments, threaded rods, threaded nuts, teeth, gears, chip breakers...) as well as plastic parts (eg. handles, levers, stickers, plugs, covers, squeegees, roller carriers, rubberized rolls...).
- No liability is accepted for defects caused by modifications, repairs, sharpening and manipulations not performed by the authorized personnel of the manufacturer or certified dealer or the authorized service of the manufacturer or certified dealer.
- No liability is accepted for defects resulting from corrosion, fire or water damage.
- No liability is accepted for defects resulting from external influences, such as 2-phase operation, faulty electrical protection, undervoltage, overvoltage (visibly burned components or printed circuits) except for normal deviations, lightning strikes.
- Liability according to the valid regulations of the given country for motors, electric switches/ switches, electric control boards, etc.
- Violation of the protective seal, information label or serial number, unless damage occurs during normal use. Seals and serial numbers are an integral part of the goods and do not limit the buyer's right to use and manipulate the goods to the full extent of what the goods are intended for.
- Electrical use of goods in conditions that do not correspond to their temperature, dust, humidity, chemical and mechanical influences of the environment, which is directly determined by the seller or manufacturer.
- Damage caused by excessive loading or use contrary to the conditions stated in the documentation or general principles.
- Performing an unqualified intervention or changing parameters.
- Goods that have been adjusted by the customer (painting, bending, etc.), if the defect was a result of this adjustment.
- Damage from natural elements or force majeure.
- The use of incorrect or non-genuine consumables, or any damage resulting therefrom, unless such use is normal and has not been ruled out in the operating instructions.

14. TERMS OF SERVICE

in the event of any malfunction during the warranty or post-warranty period, contact the manufacturer or a certified dealer or service center.



CE DECLARATION OF CONFORMITY CE PROHLÁŠENÍ O SHODĚ

The manufacturer / Výrobce: ADAMIK Company, s.r.o.
Registered office / Sídlo společnosti: Mitrovická 804, 739 21 Paskov, Czech Republic

whose responsibility for the relevant technical document is / jehož odpovědnost za příslušný technický dokument nese:

Name / Jméno Ing. Petr Adamík

declares under his own responsibility that the machine / na svou vlastní zodpovědnost prohlašuje, že strojní zařízení:

Product / Výrobek: Dust filtering unit / *Odsávací a filtrační jednotka*
Type / Typ: FT 416 SF, FT 416 HSF, FT 416 VSF, FT 416 VHSE,
FT 416 PEA, FT 416 PEAC, FT 416 PEAM,
FT 416 VPEA, FT 416 VPEAC, FT 416 VPEAM

Serial number / Výrobní číslo:
Year of production / Rok výroby:

complies with the requirements given in the Machinery Directive **2006/42/CE** and Low Voltage Directive **2014/35/CE**, as amended by the subsequent directives issued by the EEC Council.

Provided that the product it is used and maintained in accordance with the generally accepted codes of good practice and the recommendations of the instructions manual, meets the essential safety and health requirements of the Machinery Directive.

For the most specific risks of this machine, safety and compliance with the essential requirements of the Directive has been based on elements of:

- **EN ISO 12100:2010** - Safety of machinery, General principles for design, Risk assessment and risk reduction
- **EN 60204-1:2006+A1:2009+AC:2010** - Safety of machinery - Electrical equipment of machines- Part 1: General requirements- Industrial electrical device.

The manufacturer undertakes to transmit all the papers, in response to a reasoned request of the competent national authorities, with relevant informations on this almost-machine and leaves intact his intellectual property rights. /

*splňuje požadavky Směrnice o strojních zařízeních **2006/42/ES** a Směrnice o zařízeních nízkého napětí **2014/35/ES**, ve znění následných směrní vydaných Radou EHS.*

Za předpokladu, že je výrobek používán a udržován v souladu s obecně uznávanými kodexy správné praxe a doporučeními návodu k obsluze, splňuje základní požadavky na bezpečnost a ochranu zdraví stanovené směrníci o strojních zařízeních.

Pro nejspecifičtější rizika tohoto stroje byla bezpečnost a shoda se základními požadavky směrnice založena na prvcích:

- **EN ISO 12100:2010** - *Bezpečnost strojních zařízení, Obecné zásady pro konstrukci, Hodnocení rizik a snižování rizik*

EN 60204-1:2006+A1:2009+AC:2010 - Bezpečnost strojních zařízení - Elektrická zařízení strojů - Část 1: Obecné požadavky - Průmyslová elektrická zařízení.

Výrobce se zavazuje předat veškeré dokumenty na základě odůvodněné žádosti příslušných národních orgánů s příslušnými informacemi o tomto stroji a ponechává svá práva duševního vlastnictví nedotčena. /

Place, date / Místo, dne: Paskov, 2.4.2025

Legal representative / Zákonný zástupce společnosti:
Ing. Petr Adamík, CEO / Ing. Petr Adamík, jednatel společnosti

ADAMIK Company, s.r.o.
CZ-190 00 PRAHA 2, Palčkova 910/9
IČ: 26845318  CZ26845318



CE DECLARATION OF CONFORMITY CE PROHLÁŠENÍ O SHODĚ

The manufacturer / Výrobce: ADAMIK Company, s.r.o.
Registered office / Sídlo společnosti: Mitrovická 804, 739 21 Paskov, Czech Republic

whose responsibility for the relevant technical document is / jehož odpovědnost za příslušný technický dokument nese:
Name / Jméno Ing. Petr Adamík

declares under his own responsibility that the machine / na svou vlastní zodpovědnost prohlašuje, že strojní zařízení:

Product / Výrobek: Dust filtering unit / *Odsávací a filtrační jednotka*
Type / Typ: FT 420 SF, FT 420 HSF, FT 420 VSF, FT 420 VHSF,
FT 420 PEA, FT 420 PEAC, FT 420 PEAM,
FT 420 VPEA, FT 420 VPEAC, FT 420 VPEAM

Serial number / Výrobní číslo:
Year of production / Rok výroby:

complies with the requirements given in the Machinery Directive **2006/42/CE** and Low Voltage Directive **2014/35/CE**, as amended by the subsequent directives issued by the EEC Council.

Provided that the product it is used and maintained in accordance with the generally accepted codes of good practice and the recommendations of the instructions manual, meets the essential safety and health requirements of the Machinery Directive.

For the most specific risks of this machine, safety and compliance with the essential requirements of the Directive has been based on elements of:

- **EN ISO 12100:2010** - Safety of machinery, General principles for design, Risk assessment and risk reduction
- **EN 60204-1:2006+A1:2009+AC:2010** - Safety of machinery - Electrical equipment of machines- Part 1: General requirements- Industrial electrical device.

The manufacturer undertakes to transmit all the papers, in response to a reasoned request of the competent national authorities, with relevant informations on this almost-machine and leaves intact his intellectual property rights. /

*splňuje požadavky Směrnice o strojních zařízeních **2006/42/ES** a Směrnice o zařízeních nízkého napětí **2014/35/ES**, ve znění následných směrnic vydaných Radou EHS.*

Za předpokladu, že je výrobek používán a udržován v souladu s obecně uznávanými kodexy správné praxe a doporučeními návodu k obsluze, splňuje základní požadavky na bezpečnost a ochranu zdraví stanovené směrnicí o strojních zařízeních.

Pro nejspecifičtější rizika tohoto stroje byla bezpečnost a shoda se základními požadavky směrnice založena na prvcích:

- **EN ISO 12100:2010** - *Bezpečnost strojních zařízení, Obecné zásady pro konstrukci, Hodnocení rizik a snižování rizik*

EN 60204-1:2006+A1:2009+AC:2010 - Bezpečnost strojních zařízení - Elektrická zařízení strojů - Část 1: Obecné požadavky - Průmyslová elektrická zařízení.

Výrobce se zavazuje předat veškeré dokumenty na základě odůvodněné žádosti příslušných národních orgánů s příslušnými informacemi o tomto stroji a ponechává svá práva duševního vlastnictví nedotčena. /

Place, date / Místo, dne: Paskov, 2.4.2025

Legal representative / Zákonný zástupce společnosti:

Ing. Petr Adamík, CEO / Ing. Petr Adamík, jednatel společnosti

ADAMIK Company, s.r.o.
CZ-190 00 PRAHA 2, Paříkova 910/9
IČ: 26845318  CZECH REPUBLIC
.....



CE DECLARATION OF CONFORMITY CE PROHLÁŠENÍ O SHODĚ

The manufacturer / Výrobce: ADAMIK Company, s.r.o.
Registered office / Sídlo společnosti: Mitrovická 804, 739 21 Paskov, Czech Republic

whose responsibility for the relevant technical document is / jehož odpovědnost za příslušný technický dokument nese:

Name / Jméno Ing. Petr Adamík

declares under his own responsibility that the machine / na svou vlastní zodpovědnost prohlašuje, že strojní zařízení:

Product / Výrobek: Dust filtering unit / *Odsávací a filtrační jednotka*
Type / Typ: FT 440 SF, FT 440 HSF, FT 440 VSF, FT 440 VHSF,
FT 440 PE A, FT 440 PEAC, FT 440 PEAM,
FT 440 VPEA, FT 440 VPEAC, FT 440 VPEAM

Serial number / Výrobní číslo:
Year of production / Rok výroby:

complies with the requirements given in the Machinery Directive **2006/42/CE** and Low Voltage Directive **2014/35/CE**, as amended by the subsequent directives issued by the EEC Council.

Provided that the product it is used and maintained in accordance with the generally accepted codes of good practice and the recommendations of the instructions manual, meets the essential safety and health requirements of the Machinery Directive.

For the most specific risks of this machine, safety and compliance with the essential requirements of the Directive has been based on elements of:

- **EN ISO 12100:2010** - Safety of machinery, General principles for design, Risk assessment and risk reduction
- **EN 60204-1:2006+A1:2009+AC:2010** - Safety of machinery - Electrical equipment of machines- Part 1: General requirements- Industrial electrical device.

The manufacturer undertakes to transmit all the papers, in response to a reasoned request of the competent national authorities, with relevant informations on this almost-machine and leaves intact his intellectual property rights. /

*splňuje požadavky Směrnice o strojních zařízeních **2006/42/ES** a Směrnice o zařízeních nízkého napětí **2014/35/ES**, ve znění následných směrnic vydaných Radou EHS.*

Za předpokladu, že je výrobek používán a udržován v souladu s obecně uznávanými kodexy správné praxe a doporučeními návodu k obsluze, splňuje základní požadavky na bezpečnost a ochranu zdraví stanovené směrnicí o strojních zařízeních.

Pro nejspecifičtější rizika tohoto stroje byla bezpečnost a shoda se základními požadavky směrnice založena na prvcích:

- **EN ISO 12100:2010** - *Bezpečnost strojních zařízení, Obecné zásady pro konstrukci, Hodnocení rizik a snižování rizik*

EN 60204-1:2006+A1:2009+AC:2010 - Bezpečnost strojních zařízení - Elektrická zařízení strojů - Část 1: Obecné požadavky - Průmyslová elektrická zařízení.

Výrobce se zavazuje předat veškeré dokumenty na základě odůvodněné žádosti příslušných národních orgánů s příslušnými informacemi o tomto stroji a ponechává svá práva duševního vlastnictví nedotčena. /

Place, date / Místo, dne: Paskov, 2.4.2025

Legal representative / Zákonný zástupce společnosti:
Ing. Petr Adamík, CEO / Ing. Petr Adamík, jednatel společnosti

ADAMIK Company, s.r.o.
CZ-190 00 PRAHA 2, Paříkova 910/9
IČ: 26845318  CZECH REPUBLIC
IČ: 26845318

PRODUCT QUALITY AND COMPLETENESS CERTIFICATE

Extraction device:

FT 416 SF	<input type="checkbox"/>	FT 420 SF	<input type="checkbox"/>	FT 440 SF	<input type="checkbox"/>
FT 416 VSF	<input type="checkbox"/>	FT 420 VSF	<input type="checkbox"/>	FT 440 VSF	<input type="checkbox"/>
FT 416 HSF	<input type="checkbox"/>	FT 420 HSF	<input type="checkbox"/>	FT 440 HSF	<input type="checkbox"/>
FT 416 VHSF	<input type="checkbox"/>	FT 420 VHSF	<input type="checkbox"/>	FT 440 VHSF	<input type="checkbox"/>
FT 416 PEA	<input type="checkbox"/>	FT 420 PEA	<input type="checkbox"/>	FT 440 PEA	<input type="checkbox"/>
FT 416 VPEA	<input type="checkbox"/>	FT 420 VPEA	<input type="checkbox"/>	FT 440 VPEA	<input type="checkbox"/>
FT 416 PEAC	<input type="checkbox"/>	FT 420 PEAC	<input type="checkbox"/>	FT 440 PEAC	<input type="checkbox"/>
FT 416 VPEAC	<input type="checkbox"/>	FT 420 VPEAC	<input type="checkbox"/>	FT 440 VPEAC	<input type="checkbox"/>
FT 416 PEAM	<input type="checkbox"/>	FT 420 PEAM	<input type="checkbox"/>	FT 440 PEAM	<input type="checkbox"/>
FT 416 VPEAM	<input type="checkbox"/>	FT 420 VPEAM	<input type="checkbox"/>	FT 440 VPEAM	<input type="checkbox"/>
.....	<input type="checkbox"/>				

Serial number:	Checked by:	Date:
-----------------------	--------------------	--------------

Date of sale:	Delivered by:
----------------------	----------------------

Service / repair protocol:

The date of acceptance for repair:	Description:	Repaired by:

v.2026.04

ADAMIK Company, s.r.o.
Mitrovická 804, 739 21 Paskov
Czech Republic

VAT ID: CZ26845318
Tel.: +420 774 883 858
e-mail: info@adamikcompany.com

www.adamikcompany.com